



**ELECTRONIC
INNOVATIONS
IN ACTION**

TUBES

Beam Pentode

6550-A

FOR AF POWER-AMPLIFIER APPLICATIONS

■ **AUDIO POWER OUTPUT**

■ **UP TO 100 WATTS OUTPUT - 2 TUBES IN PUSH-PULL**

■ **42 WATTS PLATE DISSIPATION**

The 6550-A is a beam-power pentode primarily designed for use in audio-frequency power-amplifier applications. It carries a 42 watt plate dissipation rating which provides for push-pull amplifier designs up to 100 watts output.

The 6550-A features a straight sided T-14 envelope and may be used as a direct replacement for the 6550.

GENERAL

ELECTRICAL

Cathode - Coated Unipotential	
Heater Characteristics and Ratings	
Heater Voltage, AC or DC *	6.3±0.6 Volts
Heater Current •	1.6 Amperes
Direct Interelectrode Capacitances ▲	
Grid-Number 1 to Plate: (g1 to p)	0.8 pf
Input: g1 to (h+k+g2+b.p.)	15 pf
Output: p to (h+k+g2+b.p.)	10 pf

MECHANICAL

Mounting Position - Any	
Envelope - T-14, Glass	
Base - B7-99, Large-Wafer Octal with Sleeve Low Loss 7-Pin Micanol	
Outline Drawing - EIA 14-16	
Maximum Diameter	1.813 Inches
Minimum Bulb Diameter	1.687 Inches
Maximum Over-all Length	4.562 Inches
Maximum Seated Height	4.000 Inches
Minimum Seated Height	3.750 Inches

PHYSICAL DIMENSIONS

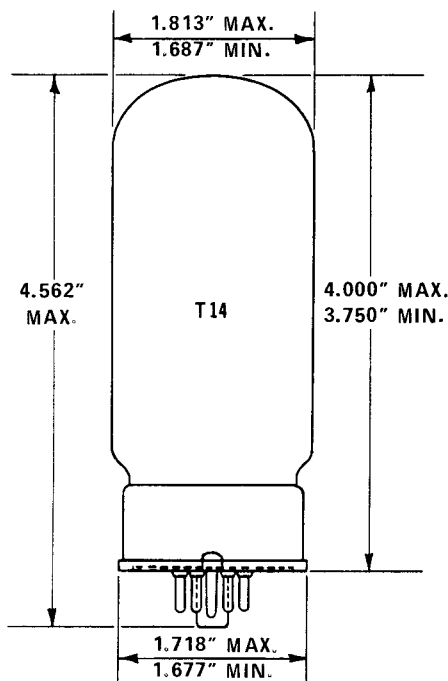

EIA 14-16

TERMINAL CONNECTIONS

- Pin 1 - No Connection or Base Shell
- Pin 2 - Heater
- Pin 3 - Plate
- Pin 4 - Grid-Number 2 (Screen)
- Pin 5 - Grid-Number 1
- Pin 7 - Heater
- Pin 8 - Cathode and Beam Plates

BASING DIAGRAM

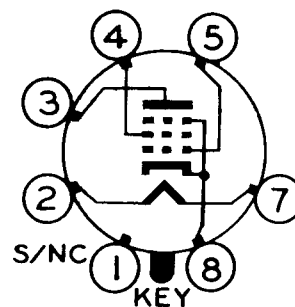

EIA 7AC

MAXIMUM RATINGS

DESIGN-MAXIMUM VALUES

	Pentode Connection	Triode Connection †	
DC Plate Voltage.....	660	500	Volts
DC Screen Voltage.....	440§	---	Volts
Positive DC Grid-Number 1 Voltage.....	0	0	Volts
Negative DC Grid-Number 1 Voltage.....	300	300	Volts
Plate Dissipation.....	42	42	Watts
Screen Dissipation (Average).....	6.0	---	Watts
Screen Dissipation (Peak).....	10	---	Watts
DC Cathode Current.....	190	190	Milliamperes
Heater-Cathode Voltage			
Heater Positive with Respect to Cathode			
DC Component.....	100	100	Volts
Total DC and Peak.....	200	200	Volts
Heater Negative with Respect to Cathode			
Total DC and Peak.....	300	300	Volts
Grid-Number 1 Circuit Resistance			
With Fixed Bias.....	0.05	0.05	Megohms
With Cathode Bias.....	0.25	0.25	Megohms
Bulb Temperature at Hottest Point ⊕.....	250	250	°C

Design-Maximum ratings are limiting values of operating and environmental conditions applicable to a bogey electron tube of a specified type as defined by its published data and should not be exceeded under the worst probable conditions.

The tube manufacturer chooses these values to provide acceptable serviceability of the tube, making allowance for the effects of changes in operating conditions due to variations in the characteristics of the tube under consideration.

The equipment manufacturer should design so that initially and throughout life no design-maximum value for the intended service is exceeded with a bogey tube under the worst probable operating conditions with respect to supply-voltage variation, equipment component variation, equipment control adjustment, load variation, signal variation, environmental conditions, and variations in the characteristics of all other electron devices in the equipment.

CHARACTERISTICS AND TYPICAL OPERATION

AVERAGE CHARACTERISTICS, PENTODE CONNECTION

Plate Voltage.....	250	Volts
Screen Voltage.....	250	Volts
Grid-Number 1 Voltage.....	-14	Volts
Plate Current.....	140	Milliamperes
Screen Current.....	12	Milliamperes
Transconductance.....	11,000	Micromhos
Plate Resistance, approximate.....	15,000	Ohms
Triode Amplification Factor.....	8	
Grid-Number 1 Voltage		
I _b = 1.0 Milliamperes.....	-40	Volts

CLASS A₁ AUDIO-AMPLIFIER, SINGLE TUBE

DC Plate Voltage.....	250	400	Volts
DC Screen Voltage.....	250	225	Volts
DC Grid-Number 1 Voltage.....	-14	-16.5	Volts
Peak AF Grid-Number 1 Voltage.....	14	16.5	Volts
Zero-Signal DC Plate Current.....	140	87	Milliamperes
Maximum-Signal DC Plate Current.....	150	105	Milliamperes
Zero-Signal DC Screen Current.....	12	4.0	Milliamperes
Maximum-Signal DC Screen Current.....	22	14	Milliamperes
Load Resistance.....	1,500	3,000	Ohms
Total Harmonic Distortion.....	7	13.5	Percent
Maximum-Signal Power Output.....	12.5	20	Watts

CHARACTERISTICS AND TYPICAL OPERATION (Cont'd)**PUSH-PULL CLASS AB₁ AMPLIFIER, VALUES FOR TWO TUBES, PENTODE CONNECTION**

	Cathode Bias		Fixed Bias		
DC Plate Voltage	400	400	450	600	Volts
DC Screen Voltage	310	270	310	300	Volts
DC Grid-Number 1 Voltage.....	---	-23	-29.5	-32.5	Volts
Cathode-Bias Resistor	140	---	---	---	Ohms
Peak AF Grid-to-Grid Voltage	43	46	58	65	Volts
Zero-Signal DC Plate Current.....	170	170	150	100	Milliamperes
Maximum-Signal DC Plate Current.....	185	275	295	270	Milliamperes
Zero-Signal DC Screen Current	10	9.0	9.0	5.0	Milliamperes
Maximum-Signal DC Screen Current	25	35	38	33	Milliamperes
Effective Load Resistance, Plate-to-Plate	5,000	3,500	3,500	5,000	Ohms
Total Harmonic Distortion	0.7	0.6	1.5	3.0	Percent
Maximum-Signal Power Output	40	60	77	100	Watts

PUSH-PULL AUDIO-AMPLIFIER—ULTRA-LINEAR OPERATION, VALUES FOR TWO TUBES**SCREEN TAPPED AT 40% OF PRIMARY TURNS**

	Cathode Bias		
	Class A1	Class AB ₁	
DC Plate Voltage.....	395	450	Volts
DC Screen Voltage	395	450	Volts
DC Grid-Number 1 Voltage.....	---	-48	Volts
Cathode-Bias Resistor	200	---	Ohms
Peak AF Grid-to-Grid Voltage	70	96	Volts
Zero-Signal DC Plate Current.....	170	150	Milliamperes
Maximum-Signal DC Plate Current.....	174	265	Milliamperes
Zero-Signal DC Screen Current	12.5	12	Milliamperes
Maximum-Signal DC Screen Current	23	38	Milliamperes
Effective Load Resistance, Plate-to-Plate	5,600	4,000	Ohms
Total Harmonic Distortion	1.5	2.4	Percent
Maximum-Signal Power Output	34	70	Watts

NOTES

- * The equipment designer should design the equipment so that heater voltage is centered at the specified bogey value, with heater supply variations restricted to maintain heater voltage within the specified tolerance.
- Heater current of a bogey tube at $E_f = 6.3$ volts.
- ▲ Without external shield.
- ◆ With screen connected to plate.
- § The maximum screen voltage rating is 450 volts in push-pull circuits where the screen of each tube is connected to a tap on the plate winding of the output transformer.
- ⊕ Measured with an infrared thermometer, Ircon Model 700 BC or equivalent, at an ambient temperature of 40° C.

AVERAGE PLATE CHARACTERISTICS

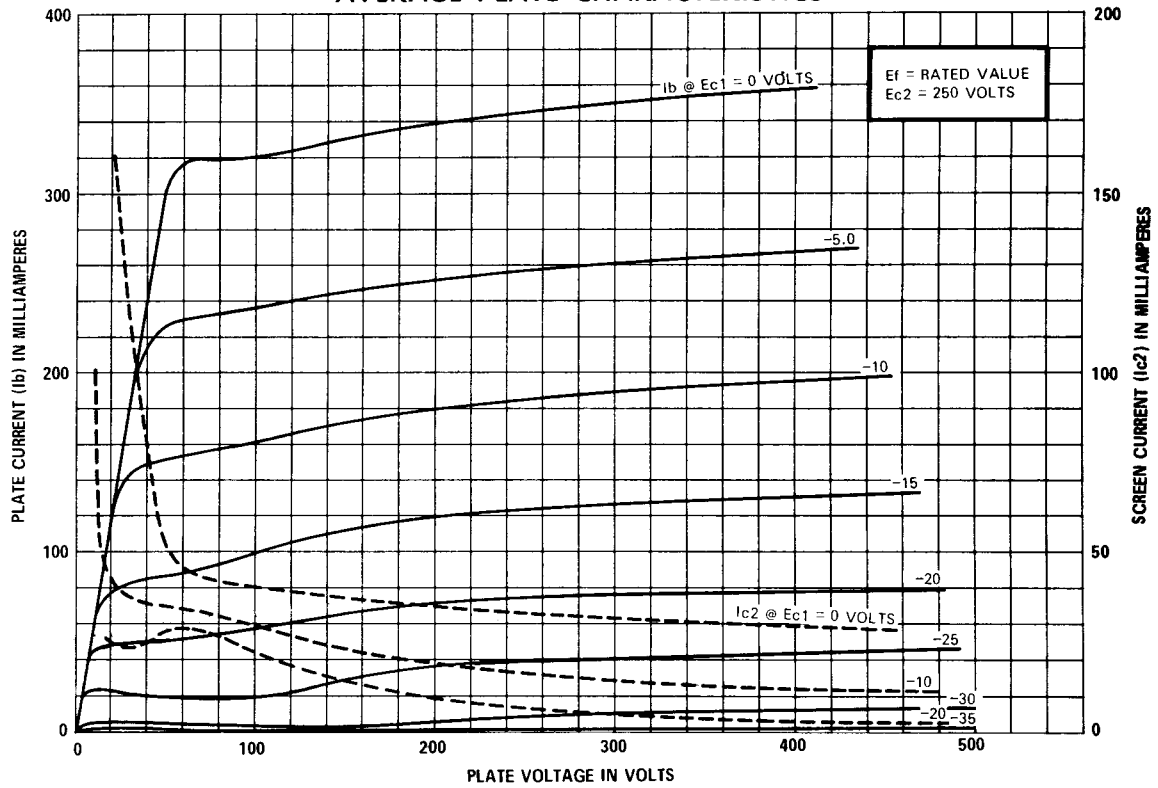

K-55611-TD379-11

AVERAGE PLATE CHARACTERISTICS

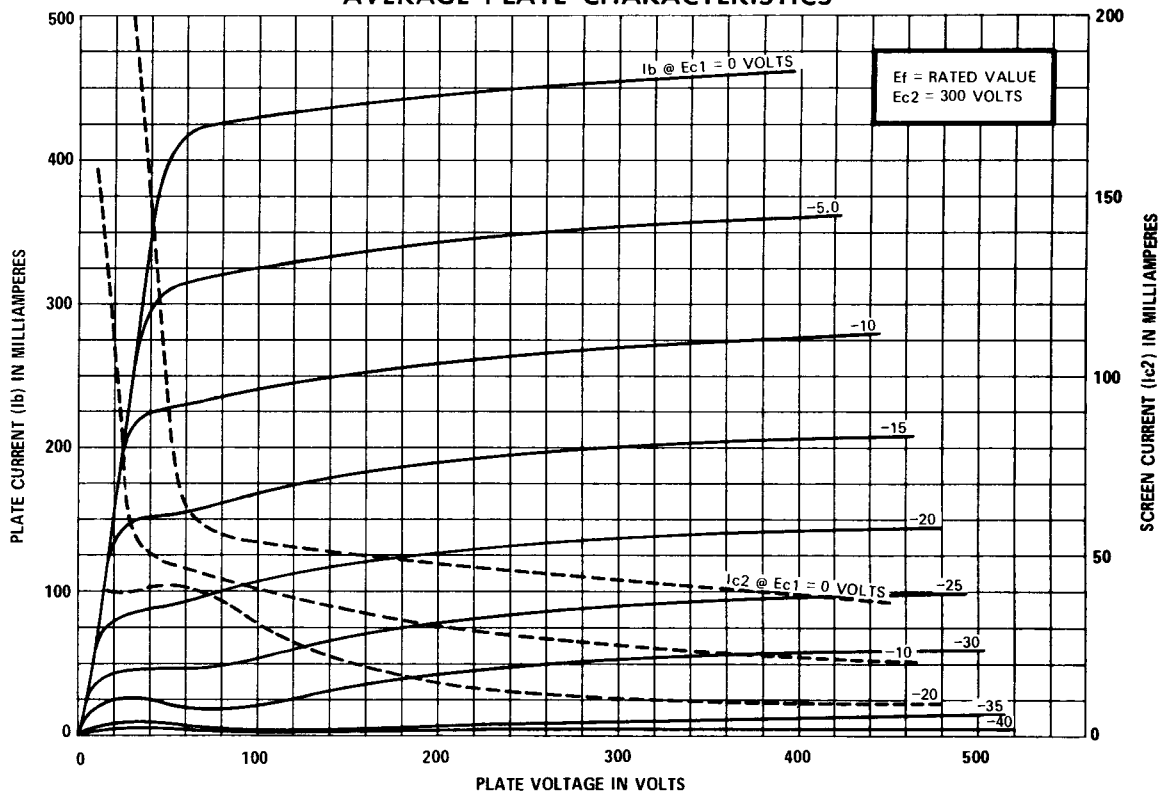

K-55611-TD379-2

AVERAGE PLATE CHARACTERISTICS

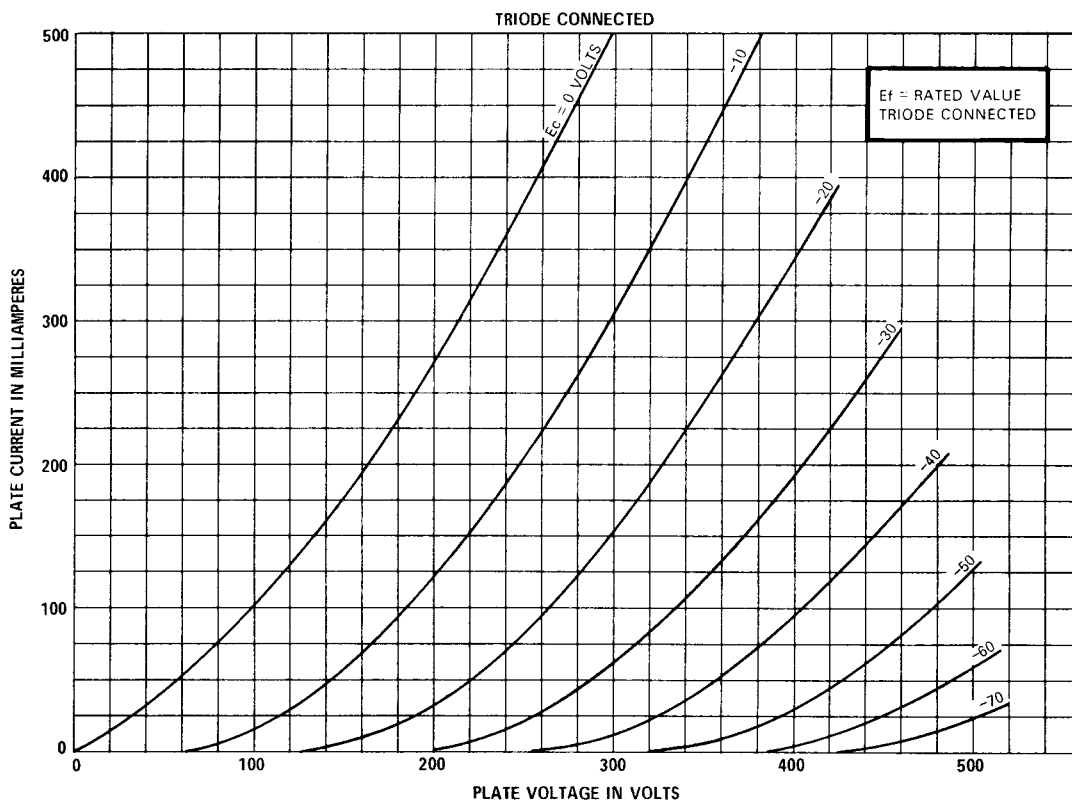

K-55611-TD379-3

AVERAGE PLATE CHARACTERISTICS

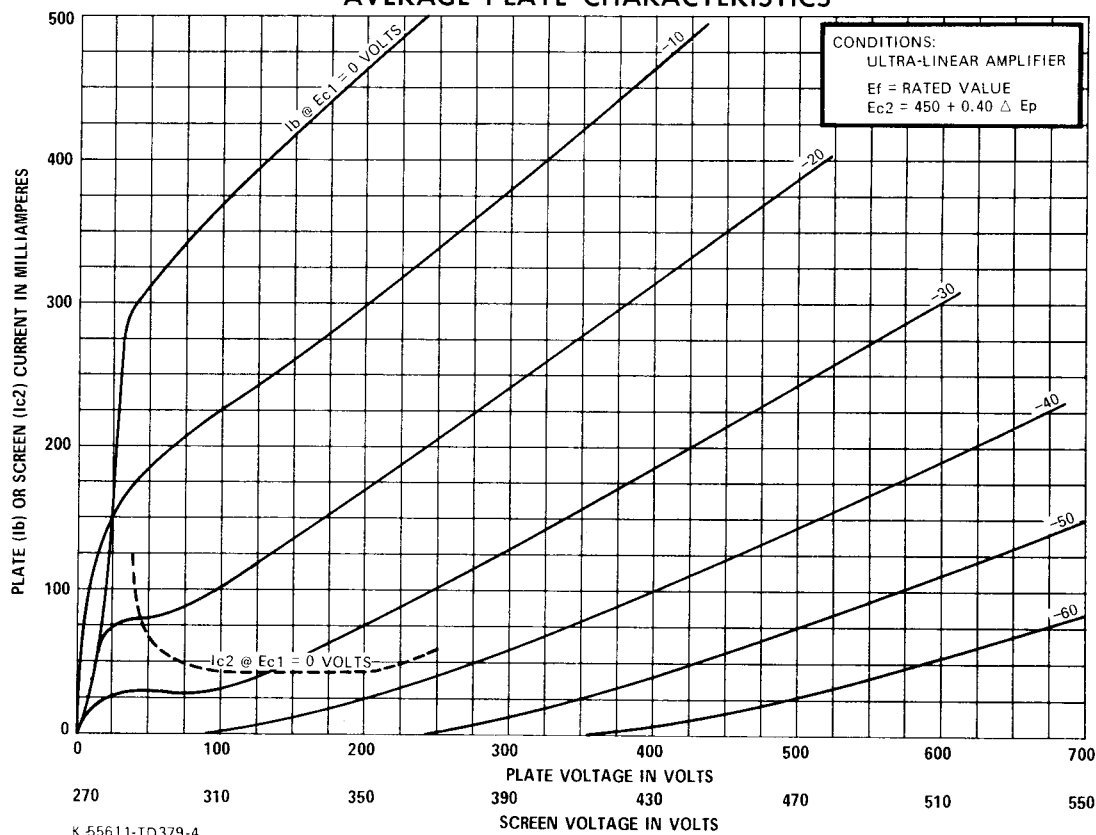

K-55611-TD379-4

AVERAGE TRANSFER CHARACTERISTICS

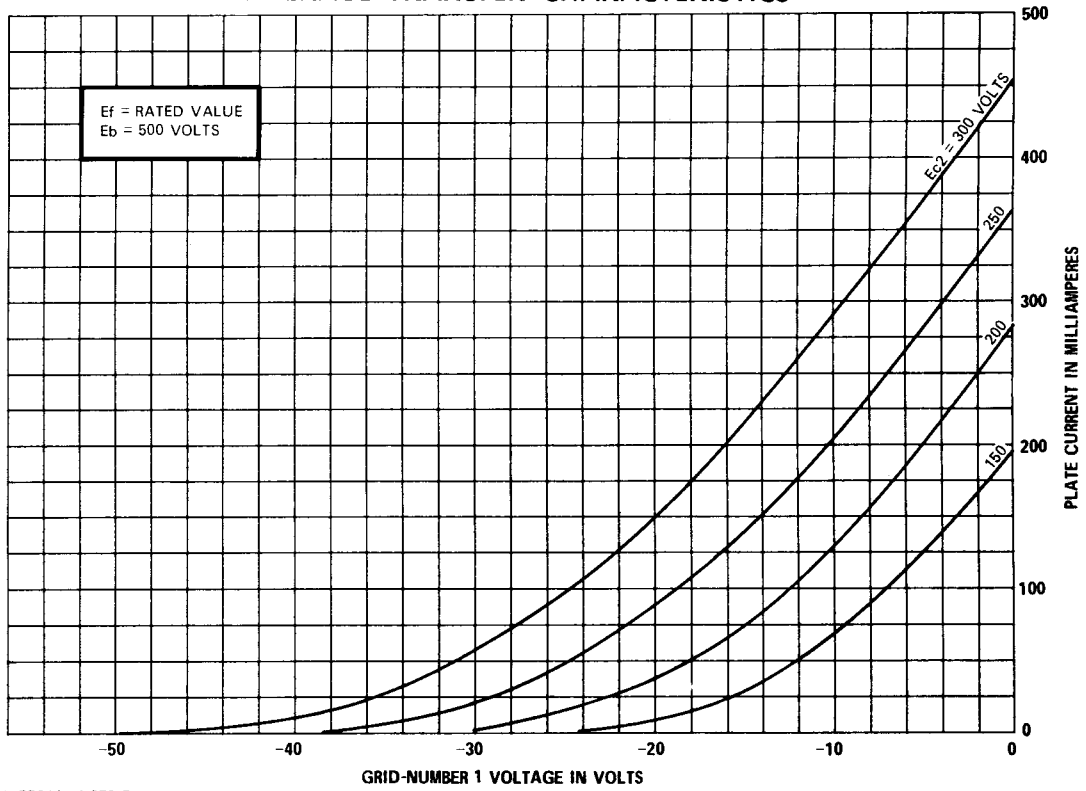

K-55611-TD379-5

OPERATION CHARACTERISTICS

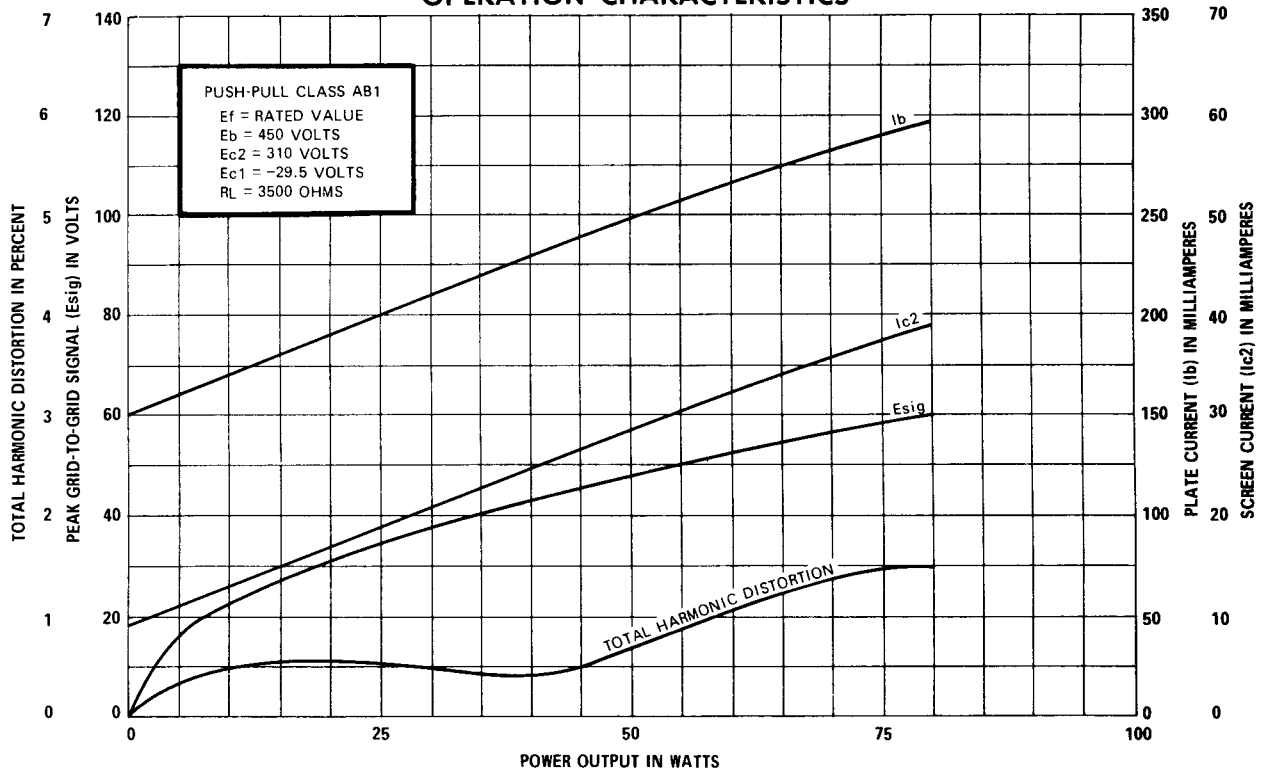

K-55611-TD379-6

OPERATION CHARACTERISTICS

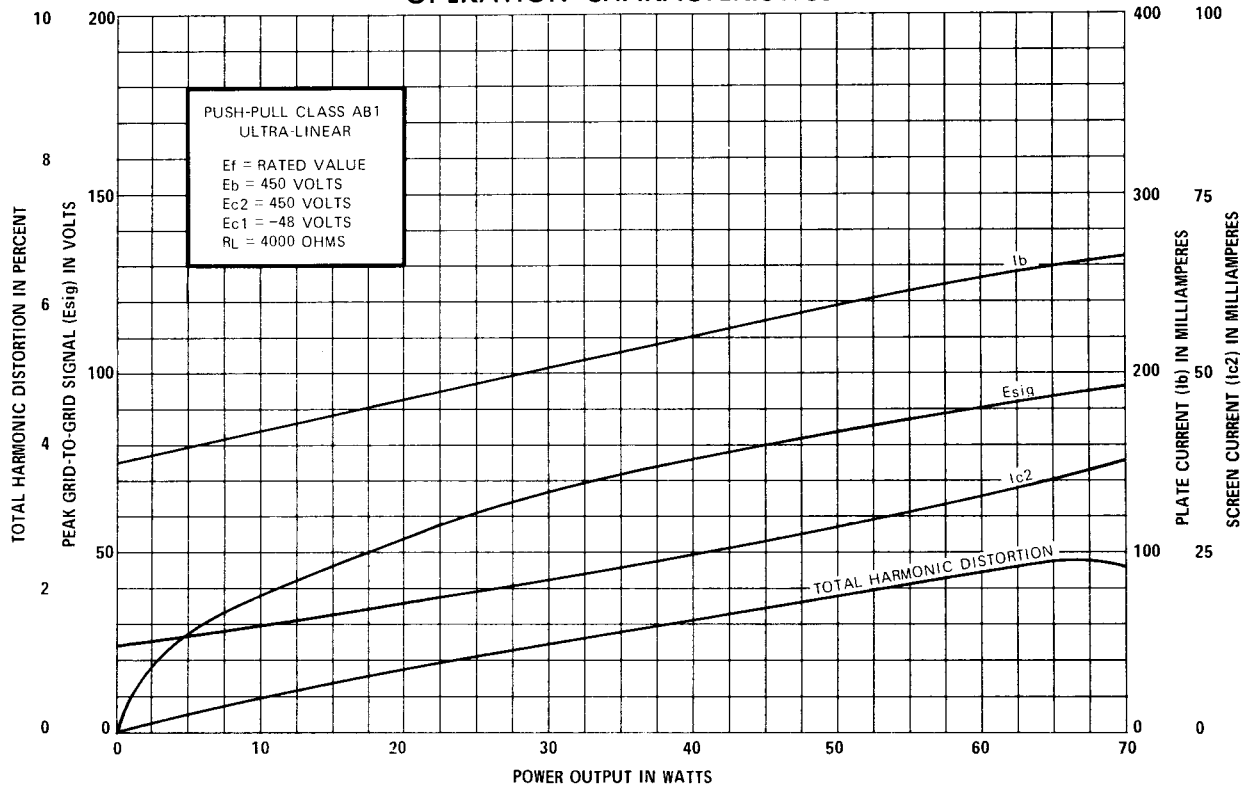

K 55611-TD379-7

OPERATION CHARACTERISTICS

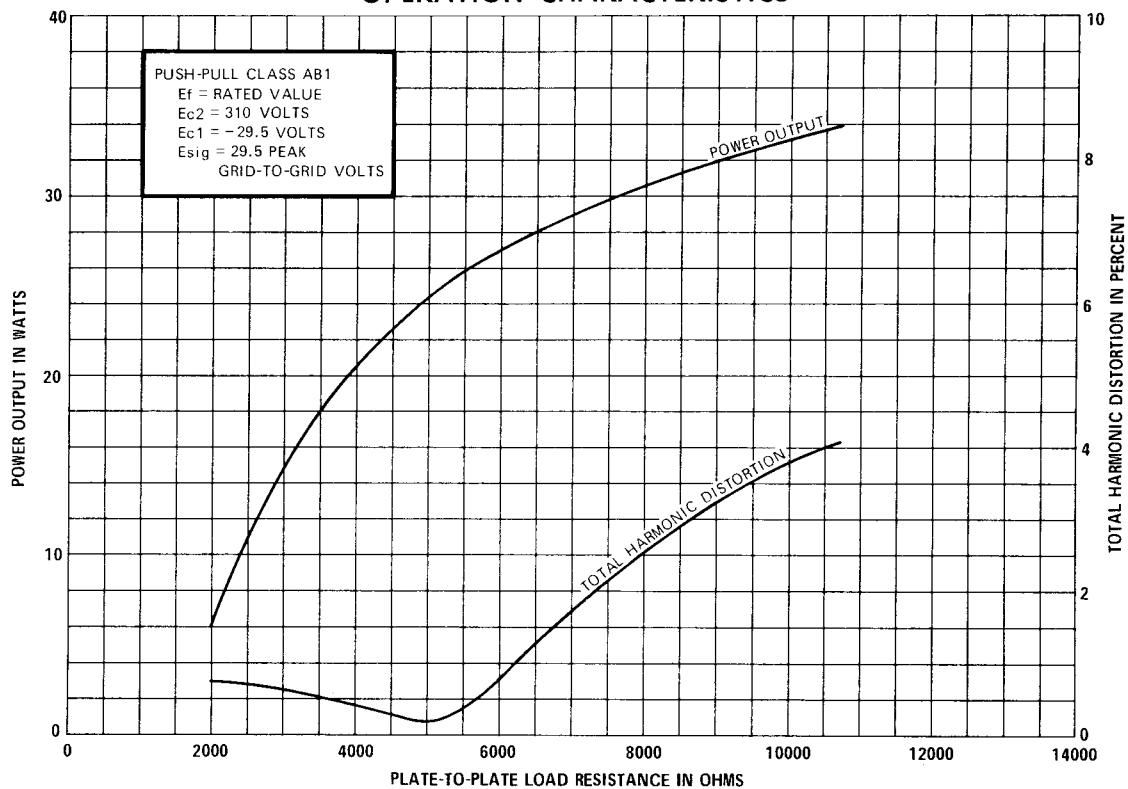

K-55611-TD379-8

OPERATION CHARACTERISTICS

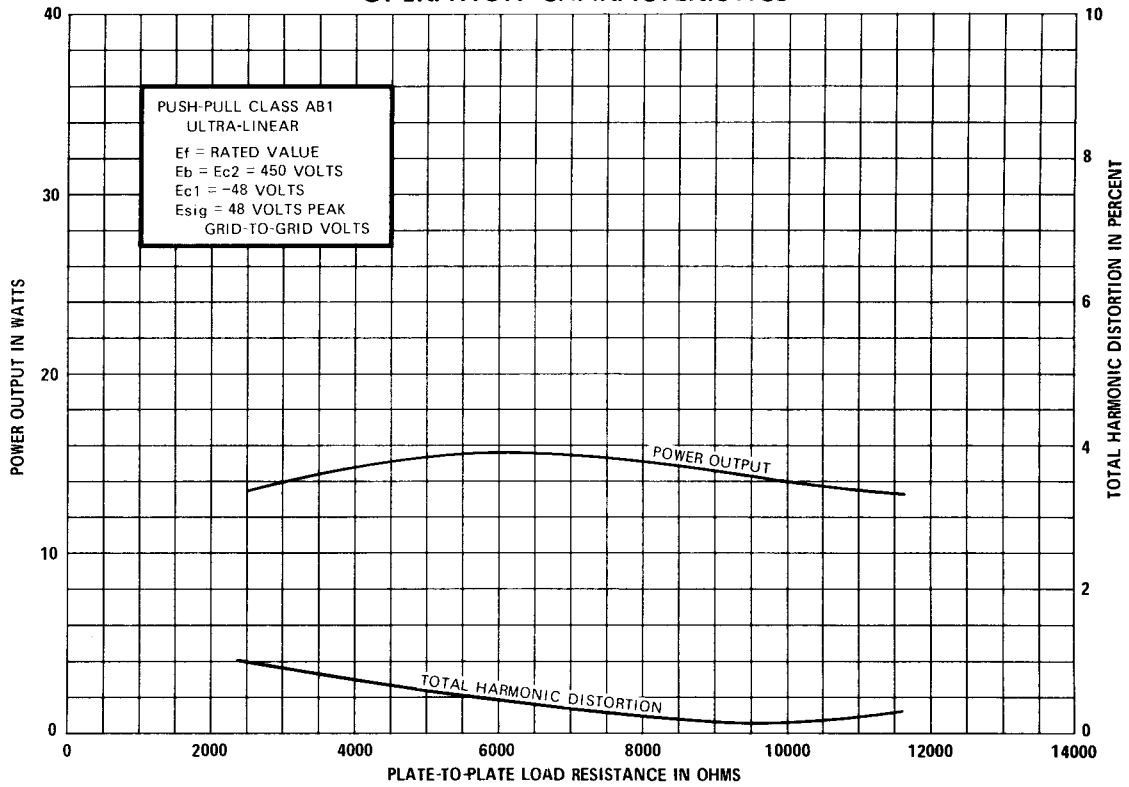

K-55611-TD379-9



TUBE PRODUCTS DEPARTMENT
OWENSBORO, KENTUCKY 42301